



**MR560C4**  
 7" TFT LCD  
 Color: Black or White  
 Hands-free operation / touch button operation  
 Surface mounted  
 Function: talking / unlocking / transferring / intercom / monitoring / picture memory and video recording for option  
 Resolution: 480x234  
 Power input: 15V  
 Working temperature: -10°C~50°C  
 Dimension: 241×161×24.5(mm)



**PL930C4**  
 HD Camera  
 Color: Black or Silver  
 Rain cover  
 Aluminum alloy panel  
 Waterproof  
 Surface mounted  
 Function: calling/talking  
 Resolution:420TV lines  
 Power output: 15V  
 Working temperature: -25°C~65°C  
 Dimension: 50 x 130 x 31(mm)











**SP24 SP26**  
 Plug power supply or DIN rail power supply  
 Output: 15V----1.5A

The multi door video entry system with its 4 wire cable connection is one that comes with 1 outdoor station, 1 indoor hands free video monitor kit. Having a maximum number of outdoor stations up to 2 and indoor monitors up to 4 gives you the perfect choice of a home video intercom system that is simple and easy to use. The new added picture memory function allows the system to take a picture automatically when someone is at the door, storing the picture in an SD card, which allows the home owner to playback for verification purpose.

#### TECHNICAL SPECIFICATIONS:

Power	DC 15V 1.5A
Illumination(minimum)	0.1 LUX
Communication duration	120s
Communication method	Duplex communication
Working temperature	-25°C ~+65°C
IP rating	55

No.	Icon	Description	No.	Icon	Description
①		Monitoring	⑤		Brightness
②		Unlocking	⑥		Chroma/contrast
③		Talking	⑦		Transferring
④		Talking volume	⑧		Ringing volume

**WIRING DIAGRAM:**

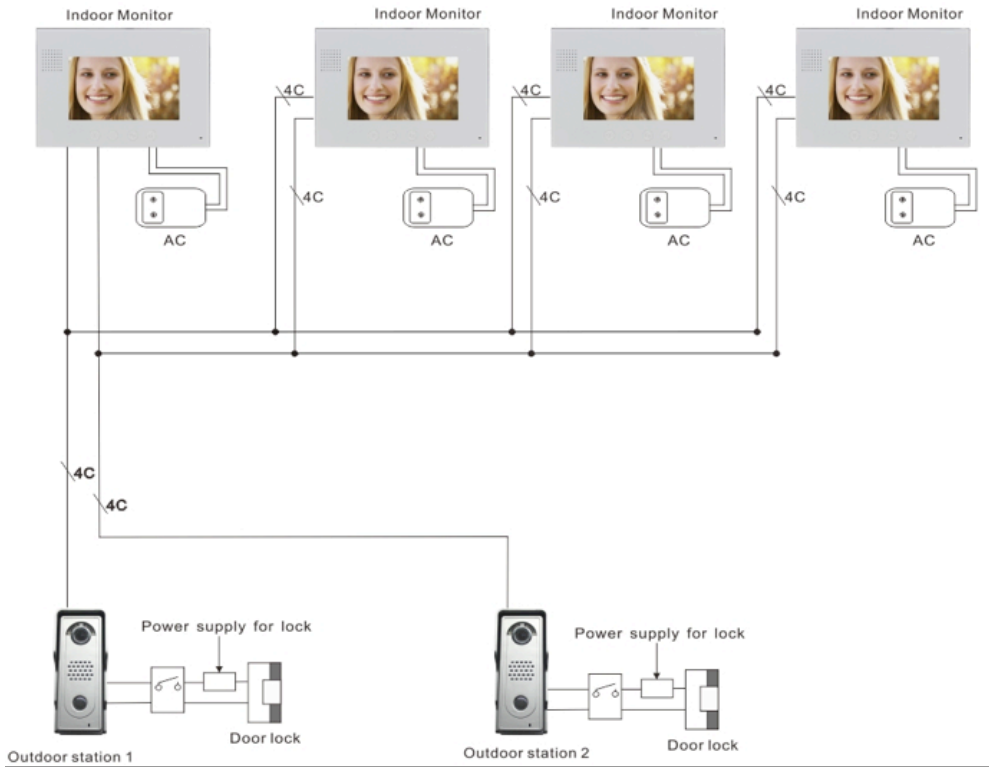

**SYSTEM DIAGRAM**

**► Wiring connection**

- 1. Blue -Audio
- 2. Black -GND
- 3. Red -V+
- 4. Yellow -Video

